

Workings on the aluminium frame DEL9LP300_.

Dimensions of the frame 26x19 mm.

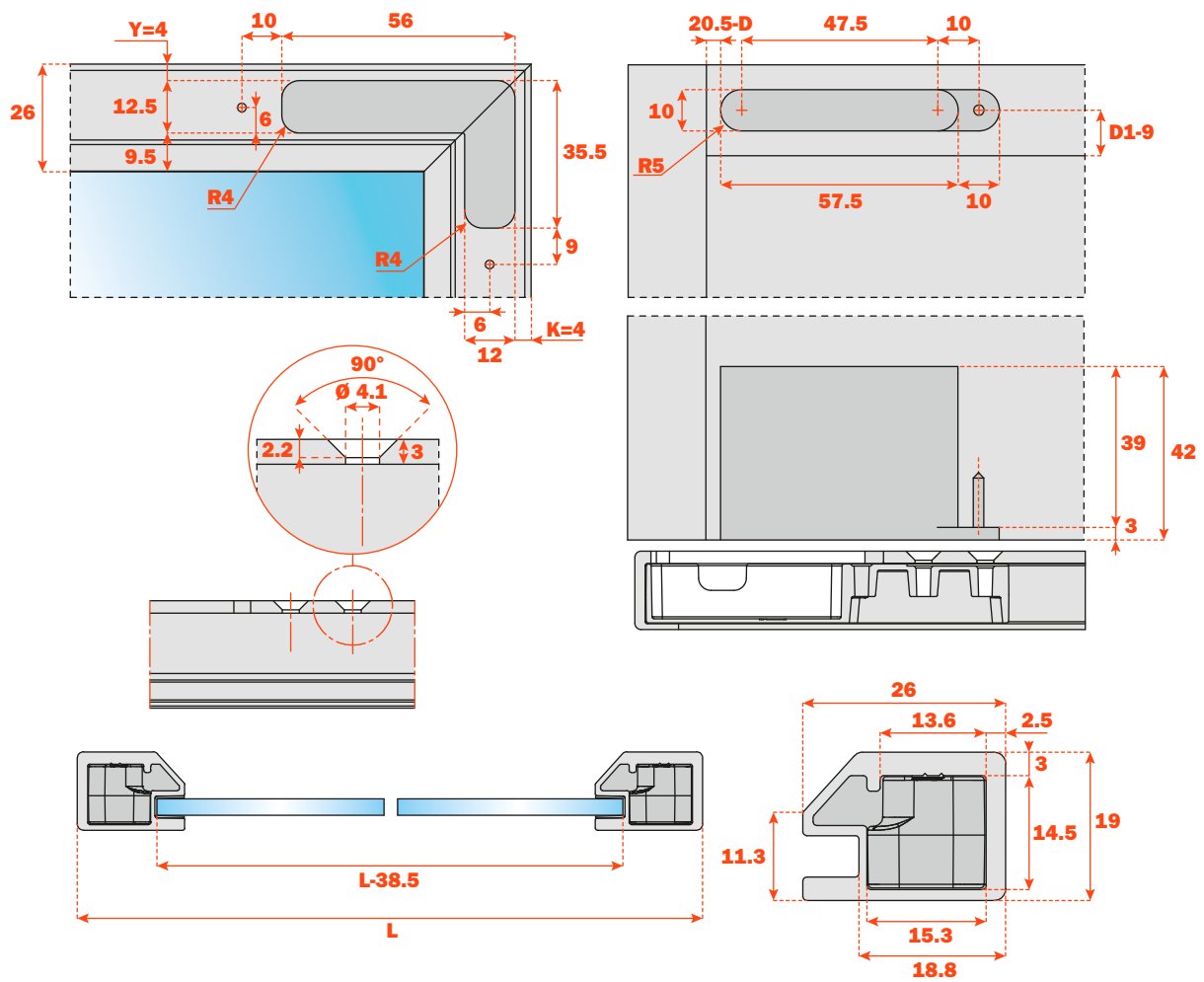

Formulas to determine the distance for the insertion of the holders for arm.

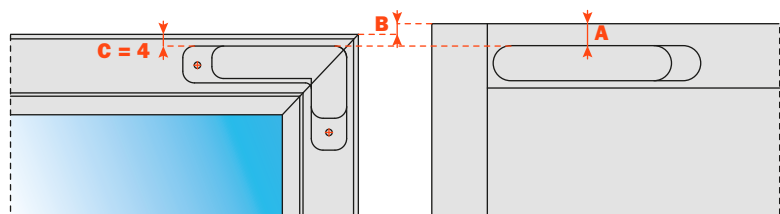

$$A = B + 4$$

$$B = A - 4$$

Air - Aluminium frame assembly

The profiles which make up the door must be cut and the ends mitred at 45°, and milled for the insertion of the corner connectors.

Insert the corner connectors into the profile and fix them with the screws provided.

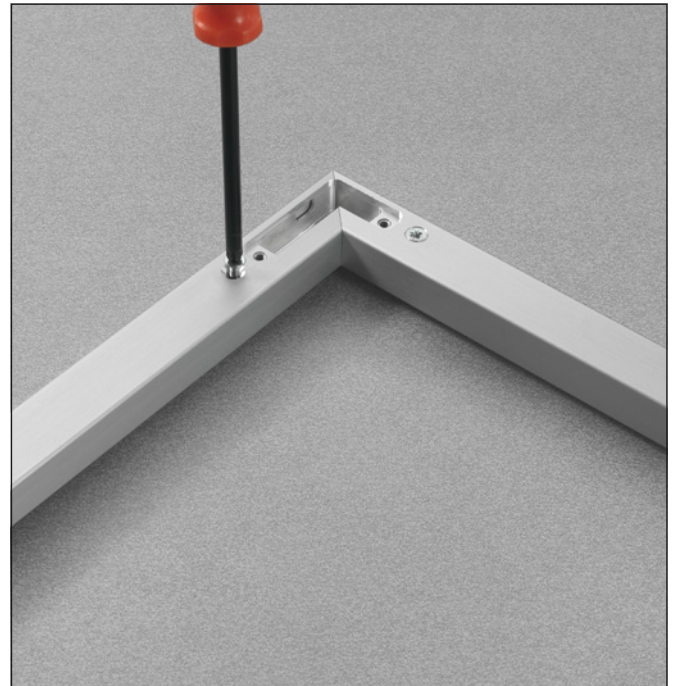
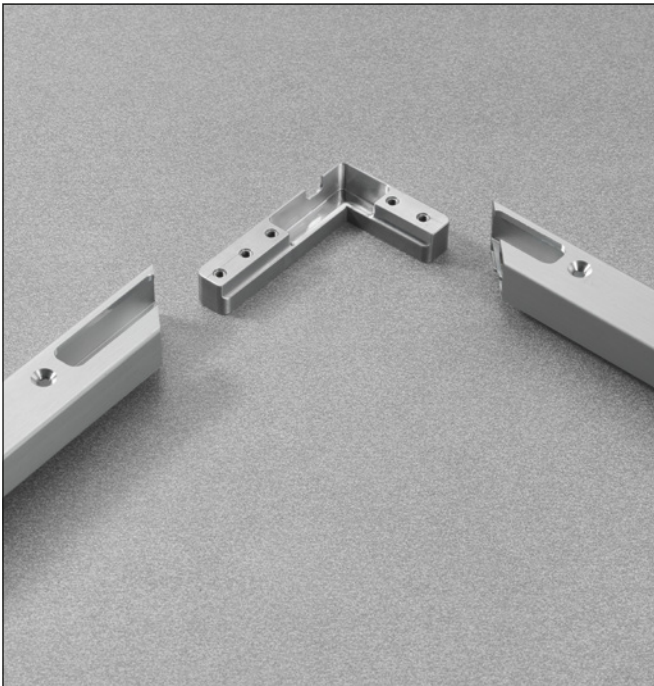

Insert the hinges into the recesses.

Fix with the screws provided.

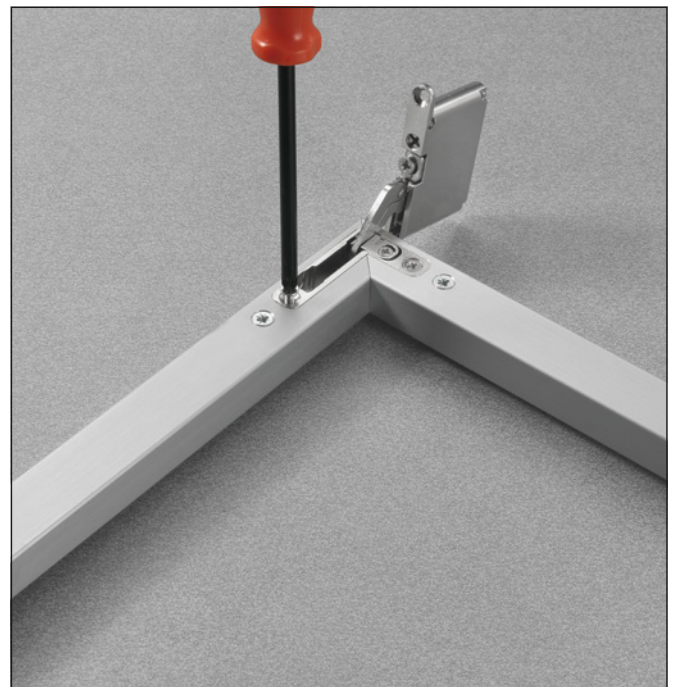
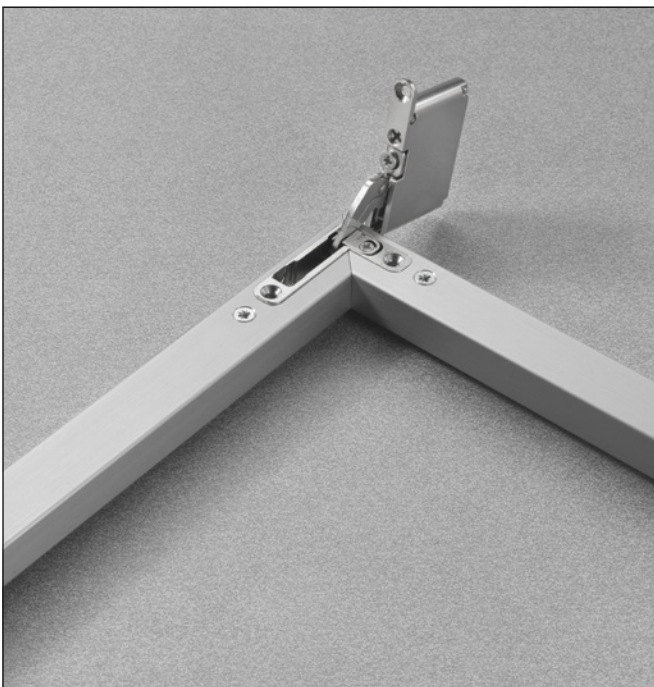

ARTURO SALICE S.p.A.

VIA PROVINCIALE NOVEDRATESE, 10
22060 NOVEDRATE (COMO) ITALIA
TEL. 031 790424 - FAX 031 791508
info.salice@salice.com - www.salice.com

DEUTSCHE SALICE GMBH

RUDOLF DIESEL STR. 10
74382 NECKARWESTHEIM
TEL. 07133 9807-0
FAX. 07133 9807-16
info.salice@deutschesalice.de
www.salice.com

DEUTSCHE SALICE GMBH

VERKAUFSBÜRO NORD
RINGSTRASSE 36/A30 CENTER
32584 LÖHNE
TEL. 05731 15608-0
FAX. 05731 15608-10
vknord@deutschesalice.de
www.salice.com

SALICE UK LTD.

KINGFISHER WAY
HINCHINGBROOKE BUSINESS PARK
HUNTINGDON CAMBS PE 29 6FN
TEL. 01480 413831
FAX. 01480 451489
info.salice@saliceuk.co.uk
www.salice.com

SALICE FRANCE S.A.R.L.

285 RUE DE GOA ZAC LES 3 MOULINS
06600 ANTIBES
TEL. 0493 330069
FAX. 0493 330141
info.salice@salicefrance.com
www.salice.com

SALICE ESPAÑA, S.L.U.

C/ AIGUAFREDA 4, P.I. AMETLLA PARK
08480 L'AMETLLA DEL VALLÈS (BARCELONA)
TEL. 0034 938 46 88 61
info.salice@saliceespana.es
www.salice.com

SALICE PORTUGAL UNIP. LDA

SHOWROOM:

TV SÁ E MELO 161 FA
4470-116 MAIA - PORTO
TEL: 00351 224 154 221
Info@saliceportugal.pt
www.salice.com

ARMAZÉM:

VIA ROTA DOS MÓVEIS I 399
4585-325 GANDRA

SALICE CHINA (SHANGHAI) CO. LTD.

1st FLOOR, B1 BLDG 928 MINGZHU ROAD
XUJING, QINGPU DISTRICT
SHANGHAI 201702 - CHINA
TEL. 021 3988 9880
FAX. 021 3988 9882
info.salice@salicechina.com
www.salicechina.com

SALICE INDIA PVT. LTD.

1001 & 1002, 10TH FLOOR,
CENTRUM, PLOT NO. C-3,
OPP. WAGLE PRABHAG SAMITI OFFICE,
MIDC AREA, WAGLE INDUSTRIAL ESTATE,
THANE - 400604, MAHARASHTRA
TEL. 022 20812050
info@saliceindia.com
www.salice.com

SALICE CANADA INC.

3500 RIDGEWAY DRIVE,
UNIT#1
MISSISSAUGA, ONTARIO, L5L 0B4
TEL. 905 820 8787
FAX. 905 820 7226
info.salice@salicecanada.com
www.salicecanada.com

SALICE AMERICA INC.

2123 CROWN CENTRE DRIVE
CHARLOTTE NC. 28227
TEL. 704 841 7810
FAX. 704 841 7808
info.salice@saliceamerica.com
www.saliceamerica.com

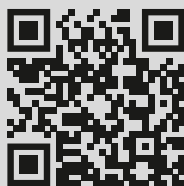

Digital contents